

OLJE 160

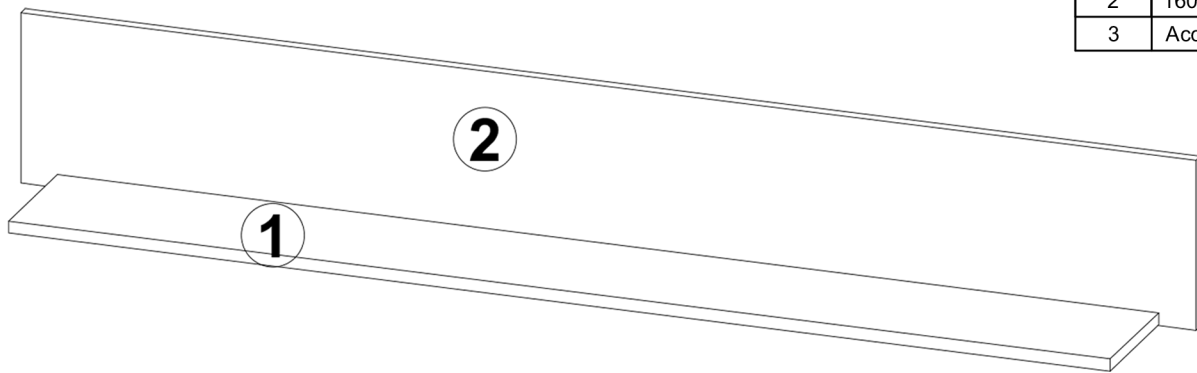

A	B			C	D
1	1500	184	16	1	1/1
2	1600	230	16	1	1/1
3	Accessories			1	1/1

max.

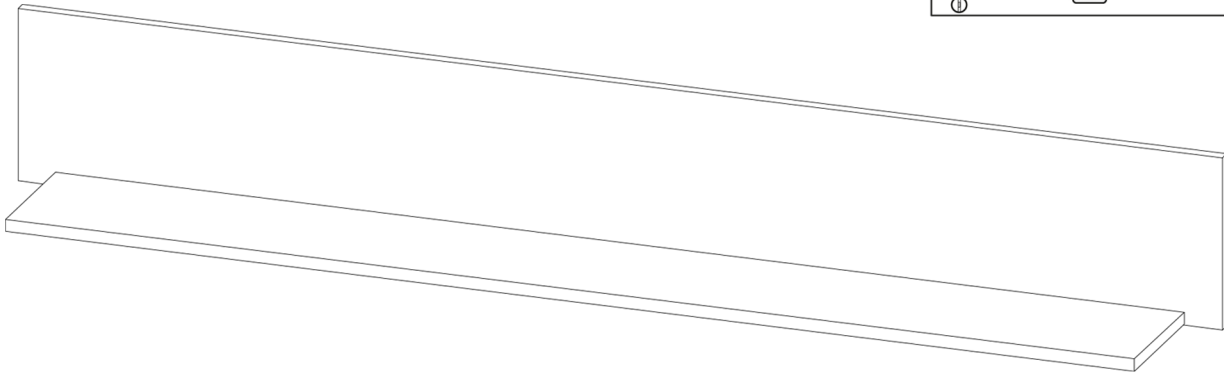
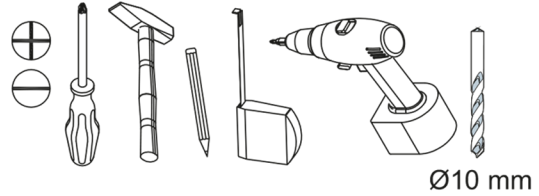
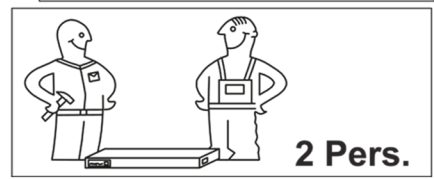
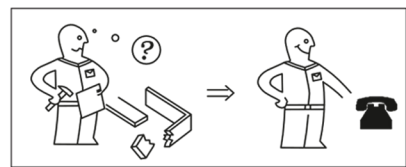
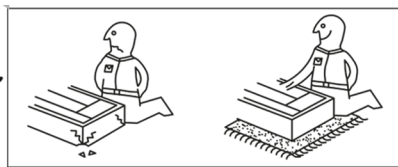
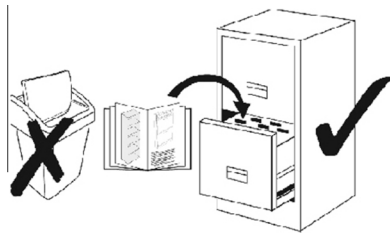
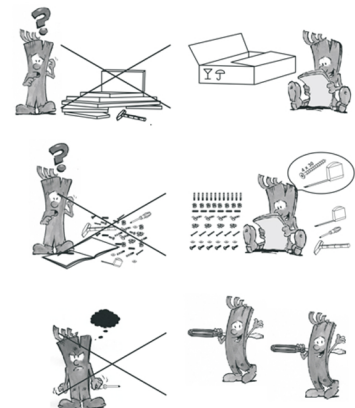
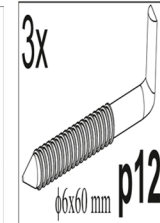
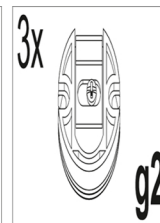
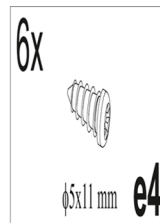
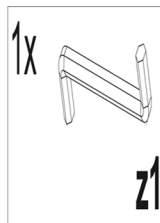
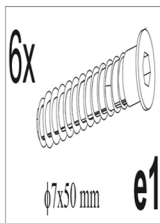
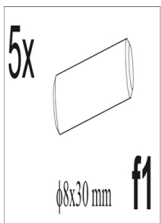

1

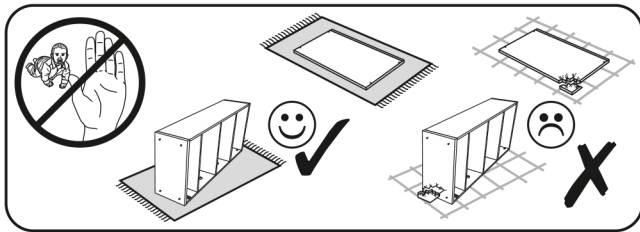

5x $\phi 8 \times 30$ mm **f1**

3x **g2**

6x $\phi 5 \times 11$ mm **e4**

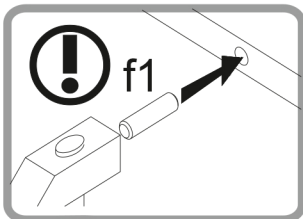
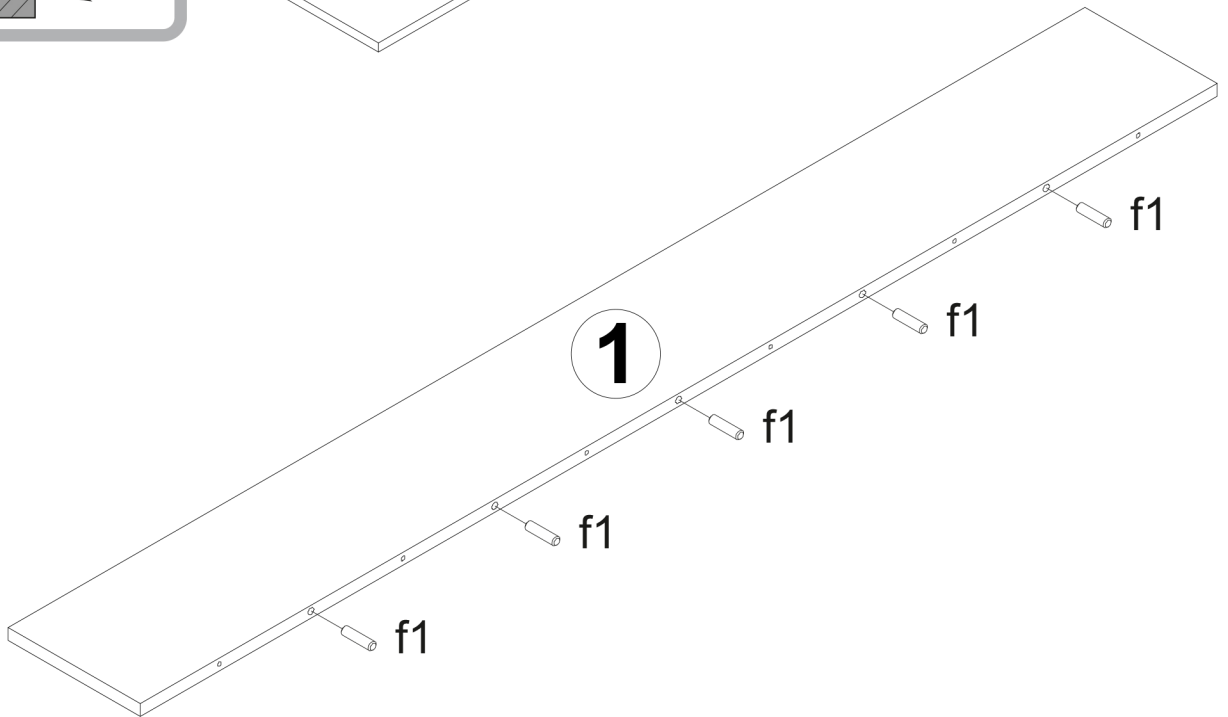
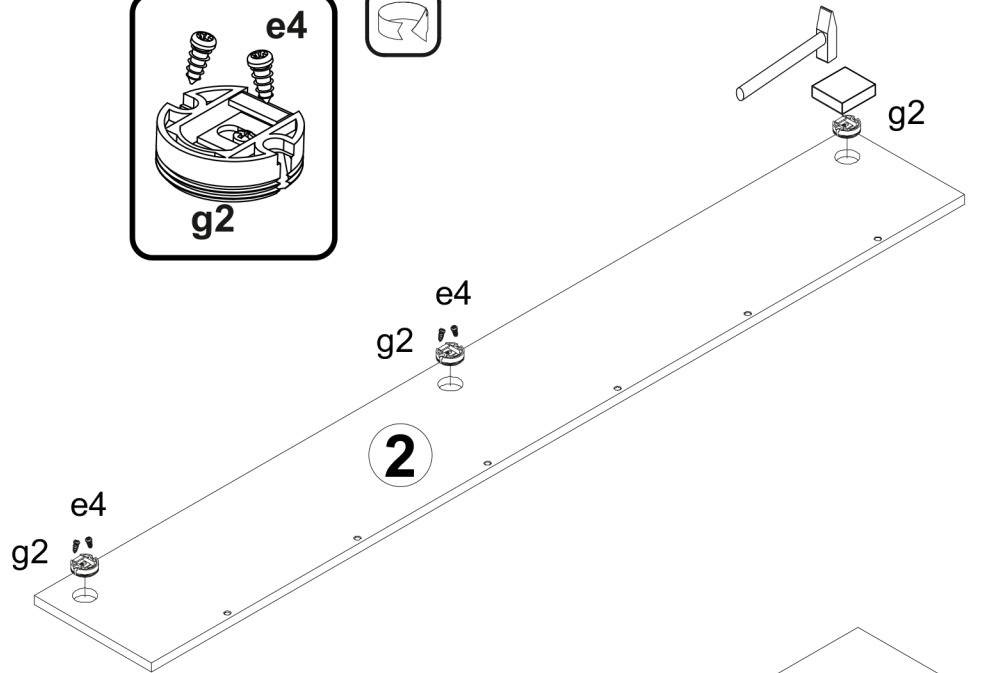
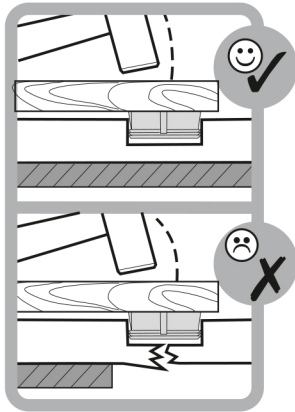
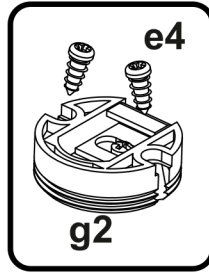

2

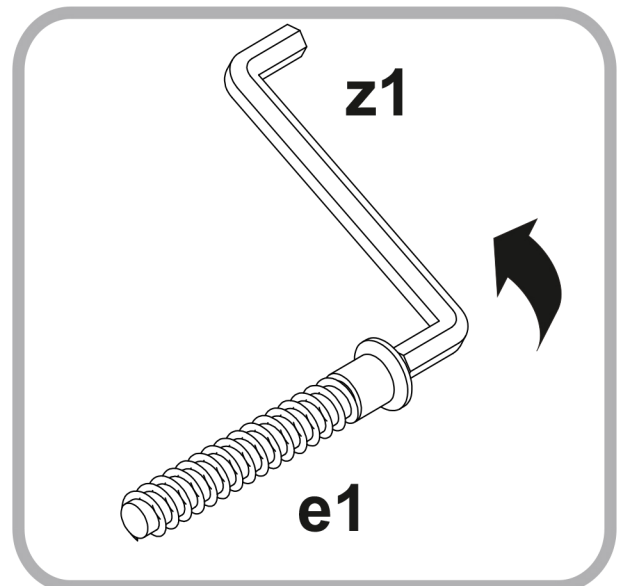
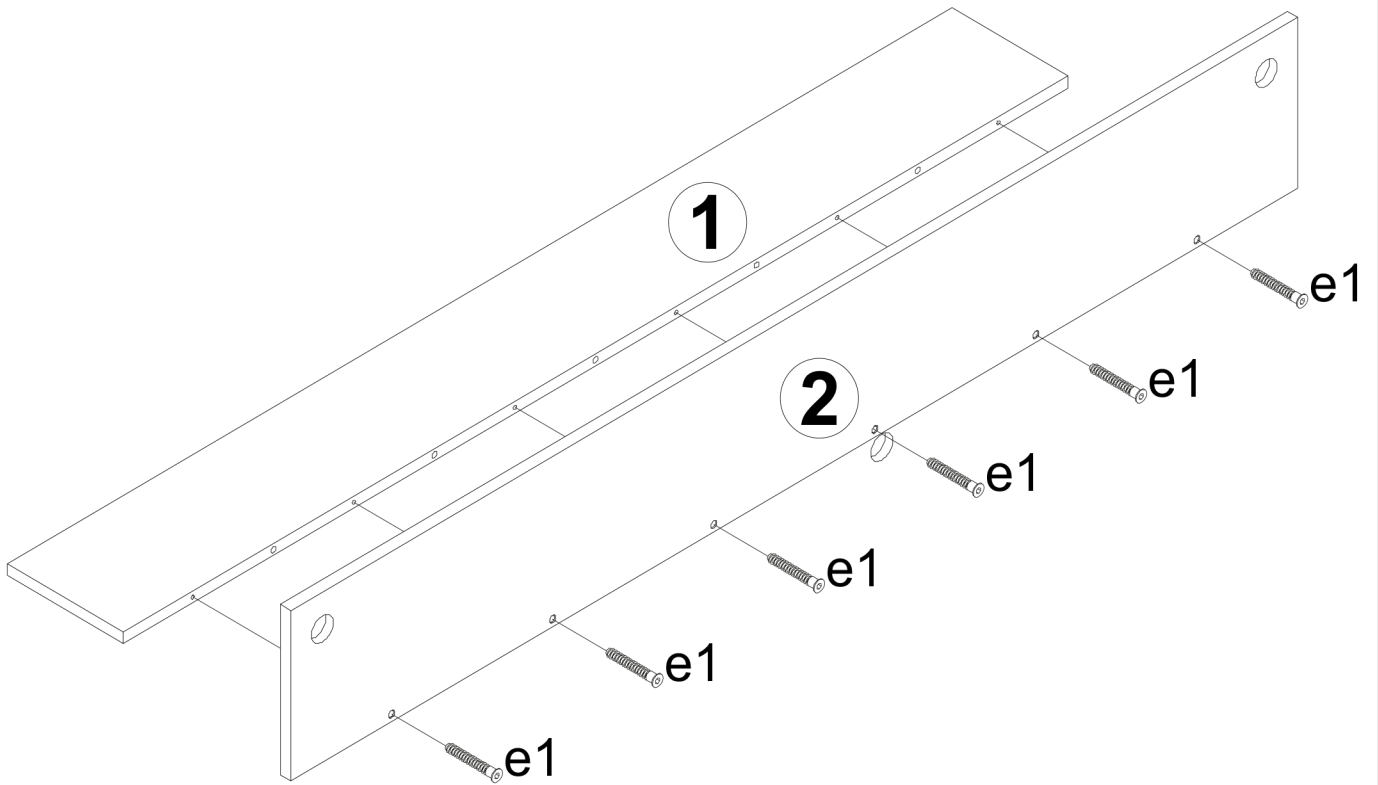
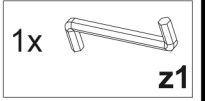

3

